



# Vehicle Return Guidelines

**IVECO**  
CERTIFIED PRE-OWNED

**IVECO**  
Drive the road of change



# Foreword

Dear customer,

This damage catalogue aims to prepare you for returning your IVECO vehicle when your usage period comes to an end.

The returned vehicle must comply with its original description, in particular the optional extras, accessories and equipment. Furthermore, the vehicle must only be fitted with parts recommended by the manufacturer.

The examples provided not only show the most common traces of wear caused by normal vehicle use but also the most common types of deterioration due to improper use.

Traces of wear accompanied by a green symbol in the following pages do not, in principal, incur any fees and are not subject to additional costs as per IVECO return conditions the end of contract breakdown.

Unacceptable damage is highlighted with a red symbol. All damage is detailed in an evaluation report ordered by IVECO and carried out during an appraisal for all returned vehicles. Damage evaluation criteria is based on this document.

This damages catalogue is available and can be accessed at [www.iveco-preowned.com](http://www.iveco-preowned.com). We hope we can work cordially together and wish you a safe journey!

Your IVECO team



## Return conditions

### Return location

Vehicles are returned to storage yards as stipulated in the contract signed between the parties. The operator for the transferor must follow the rules of the IVECO return process.

### General condition of the vehicle

Each vehicle must be returned in the following condition:

- Be in working order, red malfunction warning lights for main vehicle elements off (orange warning lights not included)
- Have enough fuel, the fuel warning light off
- Be usable in complete safety for transfer by road, safety devices should be in perfect condition (e.g. no faulty brakes, tyres not worn down to the frame)
- Be serviced according to the maintenance conditions set out by the manufacturer
- Be clean on the outside and inside in order for the engineer to be able to evaluate any restoration fees
- Openings must be perfectly sealed so that the vehicle is watertight
- The structure must be damage free (skirt and rear wings intact, roof space). Vehicle should not show on HPI register with any damage classification.
- Have all the original accessories and features when returned, subsequent refitting of removable parts may be refused by the protocol
- Only parts recommended by the manufacturer should be fitted
- The vehicle must not have been subject to a theft report
- The tyre assembly must be compliant with the manufacturer's standards

Upon failure to apply or justify this, the vehicle may be refused and/or fees charged based on the conditions stipulated in the protocol signed between the parties.

## Vehicle examination

### Identification

The vehicle is identified by reading the model, chassis number (full VIN), registration number and mileage. Additional information regarding the presence of the following parts:

- Accessories and removable parts depending on the vehicle finish or model.  
Example: Additional seats, mats, luggage cover, net, wind deflectors, etc.
- Spare wheels and tools for changing/refitting wheels.  
Example: Jack, tool kit, repair kit or inflation kit, and anything delivered with the vehicle.
- Removable parts for vehicle guidance/video/audio functions.  
Example: SD card, CD-ROM, telephone, and anything stated as having been delivered with the vehicle initially and physically returned with the vehicle.
- Spare keys and vehicle key code cards.
- User manuals and maintenance booklet.

The procedure for returning certain aforementioned parts is outlined in the contract signed between the parties. The engineer will take these features into account when checking the vehicle, as will the administration team when valuating the estimation.

# Technician duties

The inspection carried out on the vehicle bodywork is static. It will take place at the storage facility under the conditions set out by the parties.

The engineer identifies the damage with low-angled light. The surveyor will identify deformations, defects, scratches, indentations, chips, corrosion, missing and broken parts as well as alignment faults. For light commercial vehicles (LCV): The damage noted is that which is visible from the front. Type of damaged detected



## Type of damaged detected

The damage detected is noted depending on its nature: Chips, scratches, indentations, broken part, missing part, defect, etc.

## Describing detected damage

Damage is detected and described depending on its size and number. It may be evaluated, simply noted as a memo, or not noted depending on the criteria below.

## Type of repair

- Fixed hourly rates: Cleaning, clearance, SR repair, buffing, etc.
- Time spent on bodywork according to the extent of the damage and the methods chosen
- Time spent on repairs, painting and spare parts based on manufacturer's schedule

Fixed fee, time and tariff tables are annexed to the contract.

## Test drive

During the test drive, the vehicle's mechanical components are assessed. You may be charged for malfunctions, according to the rules specified in the contract.



## TEST AT IDLE – TRAFFIC JAM SPEED

- Standard start-up, on all cylinders
- Automatic transmission: Checking of locking in position "P" on a slope and no start-up with gear engaged
- Regular operation at idle
- Full lock from left to right: Transmission, front axle assembly, bearings, etc.
- Fastened seatbelt warning
- Mechanical sound
- Ambient internal sound
- Air conditioning system operation
- GPS test: Programming of a destination

## ACCELERATION PHASE 50–70 KM/H

- Suspension test: Front and rear linkage assembly on uneven road or retarders
- Noises when driving: Bearings, Tyre condition
- Steering wheel: Point 0 alignment, maintenance and directional stability - steering wheel resistance
- Aerodynamic noises: Air intake, stiffling
- Clutch slipping test between 4th and 5th when going up and down gears
- GPS test - transfer and scrolling of the position (presence of CDs)

## ACCELERATION PHASE

- Clear acceleration: powertrain support test (engine silentblock), ESP, ASR (if not possible)
- Operation of supercharging system: Turbo - Compressor
- Gearbox: Switching of all gears (increase, no knocking, quick synchro)
- Mechanical vibrations: Engine, transmissions, exhaust, linkages, etc.

## DECELERATION PHASE

- Progressive braking pressed: Check efficiency, In line stability, vibrations
- Gearbox test: Change all gears down to 2nd
- ABS activation test (speed of 15-20 KM/H)
- Engine ventilation (at end of test)
- Test completion, whilst stationary, check for excess odors: Brakes, oil, exhaust, both inside and out.



## Parts checked

### ENGINE COMPARTMENT

- General appearance: Fluid leaks, traces of oil, corrosion, levels visible to the eye,
- End of longitudinal members, radiator crossmembers and elements connected
- Examination of front end
- Battery

### FRONT END

- Alignment of parts
- Roof space, cabover
- Windscreen
- Cover
- Light clusters
- Grill, front bumper
- Skirt, spoiler

### LEFT SIDE: EXTERIOR

- Alignment of parts
- Front wing
- Front wheel arch and trim
- Front wing repeater
- Rear-view mirror
- Door (s)
- Underbody
- Side panels
- Sliding door
- Shaft
- Rear wheel arch and trim
- Roof space

- Trims and roof trim
- And any element or part that is an integral part of the vehicle

### REAR END: DOORS/TAILGATE OPEN

- Roof space,
- Load stop
- Tailgate/boot trim
- Check opening of interior compartments
- Left and right boot trim
- Rear seat trim
- Breakdown accessories
- Removable parts: First aid kit, triangle, jackets, boot nets and any parts linked to the model
- Loading platform
- Side panels
- Panel trim (original, wood)
- Wheel arch
- already mentioned

### REAR END: DOORS/TAILGATE CLOSED

- Alignment of parts
- Boot/tailgate
- Rear light
- Headlights
- Plate light and support
- Bumper
- Rear skirt
- Exhaust (deformation)
- Footboard
- Optional: Tailgate operation

### REAR END: RIGHT SIDE

- Alignment of parts
- Front wing
- Front wheel arch and trim
- Front wing repeater
- Rear-view mirror
- Door (s)
- Underbody
- Side panels
- Sliding door
- Shaft
- Rear wheel arch and trim
- Roof space
- Trims and roof trim
- And any element or part that is an integral part of the vehicle

### WHEELS, RIMS AND SPARE WHEEL

- Alignment of parts
- Front wing
- Trim (steel rim)
- Size, dimensions, tyre speed index reading
- Type of spare wheel
- Tyre tread wear reading: Central, exterior
- Examination of tyre sidewall

### FRONT AND REAR SEATS

- General appearance of the vehicle: Smell, cleanliness, stains
- Operation of openings and locks
- Condition of door insides and entries
- Underbody, threshold covers. Door seals
- Window, door trim
- Floor trim
- Operation of seat controls, if present
- Seat belt
- Seat trims: Seat, backrest and headrest
- Rear-view mirror
- Windscreen
- Instrument panel and console
- Roof space, sunvisor, ceiling storage
- Load stop

### INTERIOR: DRIVER'S SEAT

- Checking of controls
- Mileage reading
- Engine start-up and notification of any warning lights that are on
- Full wheel lock for further examination of tyres



# Icon Key



## PAINTING/REPAIRS

Repair method involves remove dent and/or mastic application and/or sanding and/or plastic repair and/or painting.



## CLEANING

Chemical and mechanical process, dry or wet depending on the stain or dirty mark.



## EXCHANGE

Parts are broken or badly repaired or repair cost is higher than a new spare part. A new part is necessary.



## MEMO



# Content

External appearance of the vehicle	14
Passenger compartment	32
Additional structures	40
Vehicle technical details	54
Others	62
Appendix to the vehicle return guidelines	68



**External appearance**  
of the vehicle



# Bodywork and add-ons: chips, scratches, indentations, defects and cleaning



Chip  $\leq 5$  mm in diameter and  $\leq 20$  chips



Chip on door edge

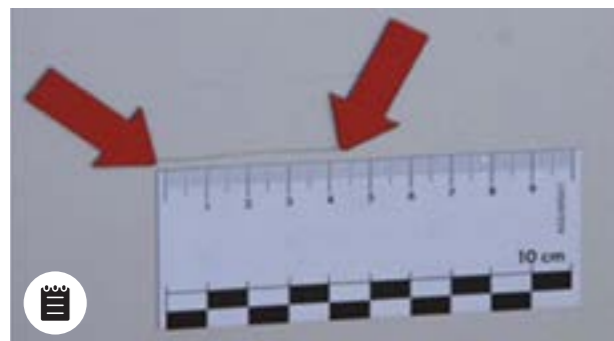



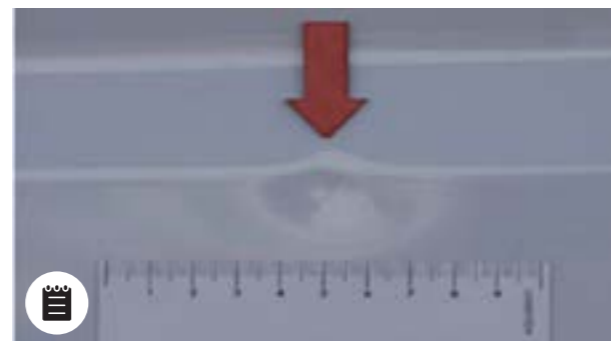



Polishable damage or scratch  $\leq 50$  mm



Indentations  $\leq 20$  mm in diameter with unaltered paint, no hail damage and significant pockmarks within in the limit of 5 indentations per panel

## Others:

-  Small grazes, e.g. on the door edges
-  Small stone impacts (no through to the base coat) on the front of the vehicle
-  Slight pollution damage, can be resolved with polishing
-  Faint marks, e.g. from car wash
-  Faint scratches in the paint at the loading edges
-  Slight differences in colour due to the use of different trims or base materials and ageing

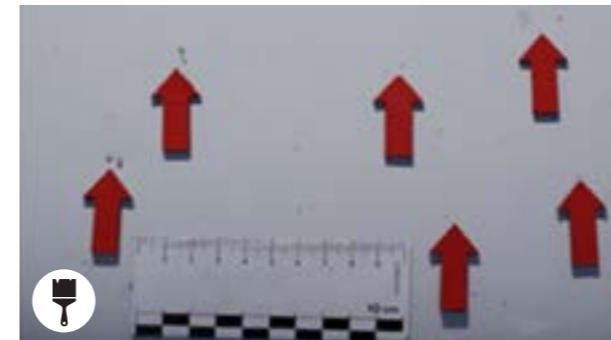

Chip  $> 5$  mm or  $> 20$  chips

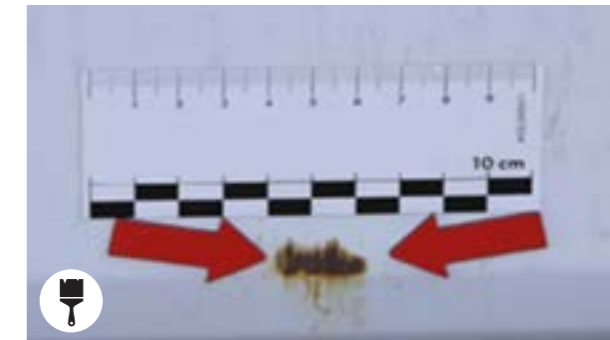

Scratches with oxidation, chemical deposit or other that cannot be cleaned



Scratches  $> 20$  mm

**Note:** On rear swinging door it is not possible to paint per half panel



Irreparable parts, beyond economic repair or non-compliant exchanged part



# Bodywork and add-ons: chips, scratches, indentations, defects and cleaning



Indentations > 20 mm in diameter, altered paint, hail damage or significant pockmarks  
 NB: Smart repair possible on isolated, significant pockmarks if paint is not altered

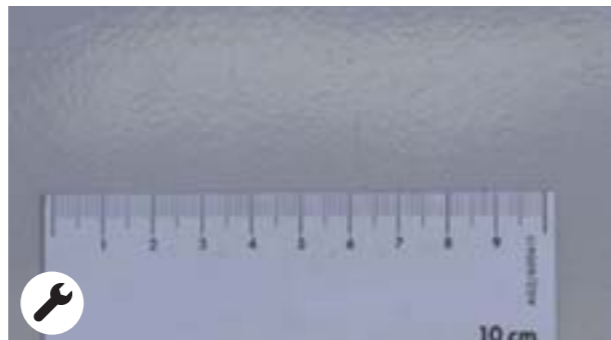

Repainted with fault (dimpled appearance). Paint too thick, insufficient, with inclusion of particles



Difference in shade following repair  
 NB: Tolerance accepted linked to ageing of the vehicle



Trace of glue. NB: Presence of tags or graffiti, valuation in real time during cleaning and/or buffing







Marks left by advertisements following the description of the bodywork.



Defect: Deformed panel following repair



## Others:

-  Significant damage due to pollution or chemical deposits, if it is necessary to restore the paint
-  Significant colour deviations e.g. following paint retouches
-  Unprofessional paint repairs
-  Large stone impacts (through to the base coat)
-  Removal of material and/or deformation of the bodywork and add-ons

# Exterior mirrors, access, doors, bumpers, rear and side underrun protections



Scratches that cannot be felt with your nail and surface  $\leq 45 \text{ cm}^2$  (equivalent to a credit card)

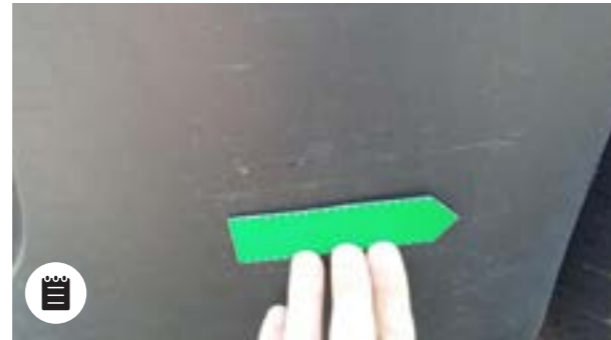

Scratches that can be felt with your nail or surface  $\leq 45 \text{ cm}^2$  (equivalent to a credit card)



Faint superficial scratches, e.g at the fuel filler cap, hatches, door handles, bumpers and trims



Faint scratches in the paint at the loading edges

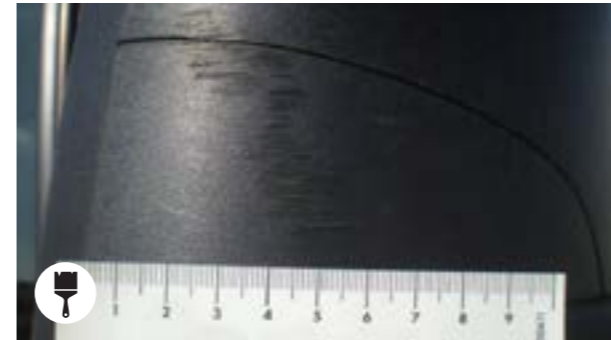

Scratches that can be felt with your nail or surface  $> 45 \text{ cm}^2$  (equivalent to a credit card)



Removal of material or deformation feasible or economical to repair



Removal of material, broken part



## Exterior mirrors, access, doors, bumpers, rear and side underrun protections

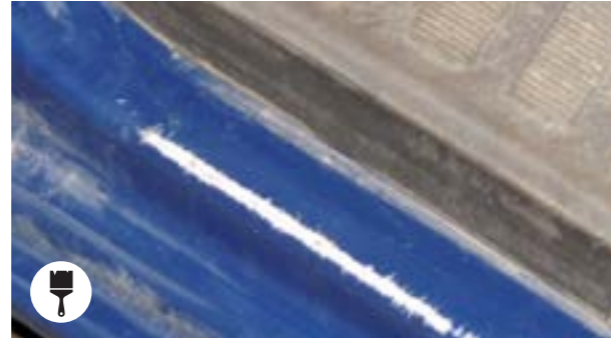

Scratches that can be felt with your nail and surface > 45 cm<sup>2</sup> (equivalent to a credit card)



Broken, removal of material or deformation beyond economic repair or not feasible



PAINTING



REPAIRS



CLEANING



EXCHANGE



MEMO





## Glazing and lights (rear and front lights)



**Nota:** Il campo visivo è definito da un foglio di carta in formato A3 posto lungo la verticale dell'asse del volante, all'altezza centrale del parabrezza.



### Others:

-  Faint scratches on the rear lights
-  Light stone impacts on the headlights
-  Stone impacts repaired professionally, not located in the driver's field of vision



PAINTING



REPAIRS



CLEANING



EXCHANGE



MEMO

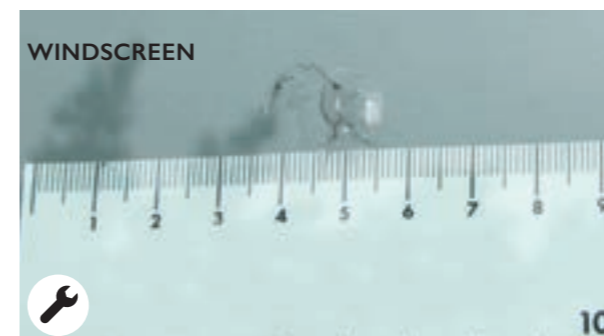

Chips  $\leq$  20 mm, outside of field of vision and  $\leq$  3 chips



Faint scratch (without removal of material), outside of lighting field and sealed light (BUFFING)

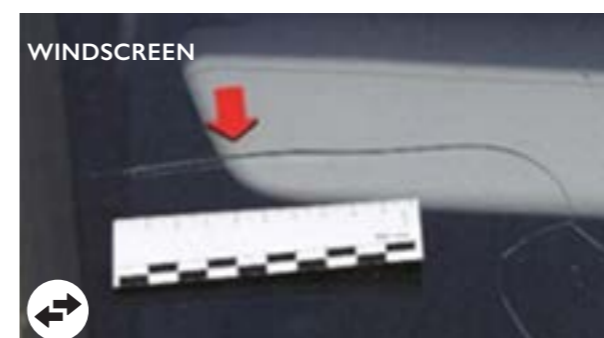

Chips  $>$  20 mm, number  $>$  3 chips, or chips in the field of vision, cracked, poorly fitted with defect, sandblasted or scratched  
**Note:** If the windshield is damaged in the driver's field of vision, local legislation must be checked.



## Glazing and lights (Rear and front lights)



Deep scratch (with removal of material), outside of lighting field and sealed light



Rear and front lights broken

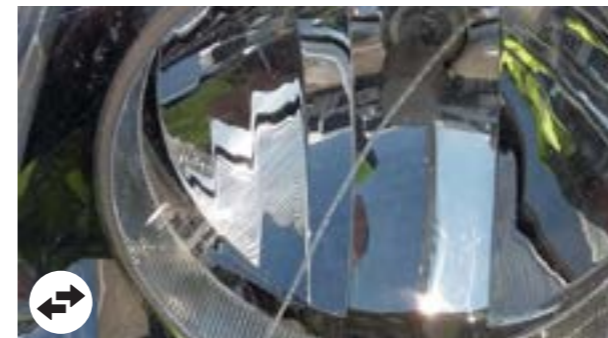

Scratch in the lighting field, crack, condensation, broken or broken fastening



# Tyres, rims and wheel covers



Tyres: Notch  $\leq$  3 mm deep (CONFORMS)



Tyres: Base of groove depth  $\geq$  5 mm (CONFORMS)  
**Note:** The wear of the tyres is measured in the most worn groove on the tyre.



Rims and wheel covers: Multiple superficial scratches with or without removal of material



Tyres: Notch  $>$  3 mm deep, removal



Wheel covers: Deformed, broken, material missing or removed



Tyres: Base of groove depth  $<$  5 mm  
**Note:** The wear of the tyres is measured in the most worn groove on the tyre.

The brand of tyre does not belong to one of the reference brands below:  
 Michelin, Kleber, Continental, Uniroyal, Bridgestone, Firestone, Good-Year, Dunlop, Pirelli, Yokohama, Hankook.

Presence of tyres made by different manufacturers on the same axle

Manufacturer's sizes and indices are not respected

A tyre is retreaded or resized

# Tyres, rims and wheel covers



On steel rim: Attachment edge slightly deformed



Wheel rim circumference, damaged non-compliant rim. Valuation of a dimensional check to check safe state of the vehicle

Cracks, deformations, significant loss of material, significant paint damage on the rims

Significant corrosion on the rims and all terrain or winter profile tyre







**Passenger** compartment

# Upholstery, floor covers, covers, trims and roof space



Light soiling can be removed by chemical cleaning carried out by a professional



Slight decolouration due to sun rays



Internal wall trim torn behind driver's seat

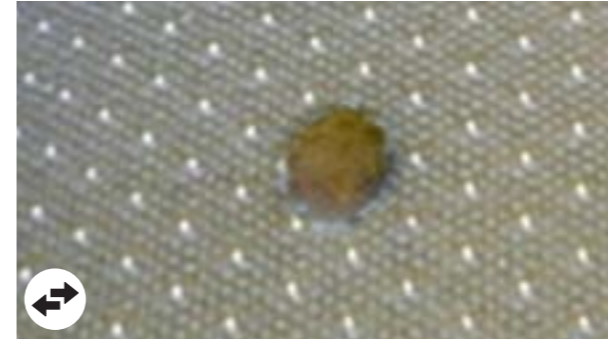

Burn > 3 mm, perforation or tear in the cover, without deterioration of the foam



Foam missing or broken frame



Perforation of hard plastic trims. Repair of hard plastic trims 1 hour flat rate if aesthetically acceptable and repairable



Fabric trim: Tear, hole > 5 mm, indelible marks

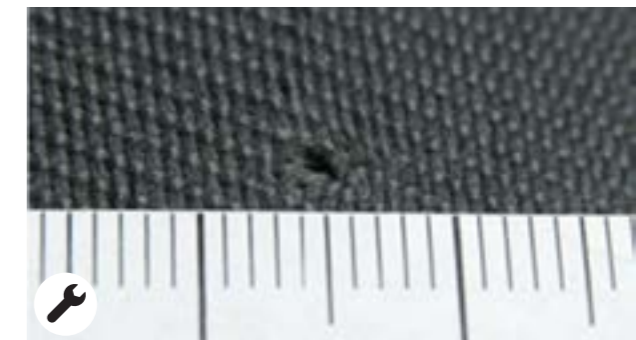

Burn ≤ 3 mm and without perforation of the cover

## Upholstery, floor covers, covers, trims and roof space



Significant soiling, stains and smells requiring chemical cleaning carried out by a professional.



Missing equipment or trims



PAINTING



REPAIRS



CLEANING



EXCHANGE



MEMO

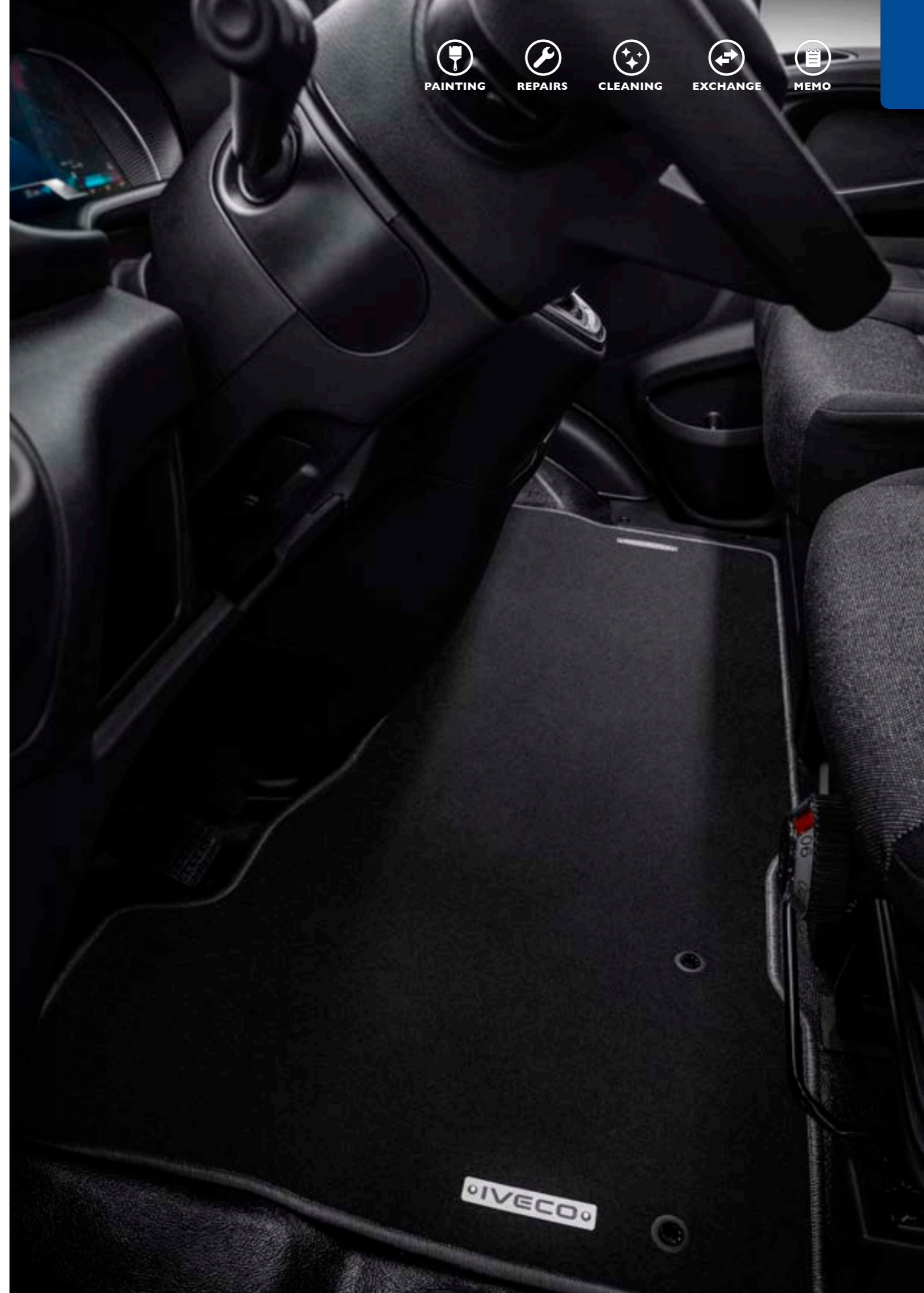

# Instrument panel, steering wheel, instruments, control systems, heating, ventilation, air conditioning, independent air conditioner, additional heating



Traces of wear on the instrument panel, instrument cluster and steering wheel



Slight discolouration due to sun exposure

Light soiling can be removed by chemical cleaning carried out by a professional



Control parts, seat or trim pieces missing, broken or pierced

Systems, seatbelt, seat control, displays and visuals not operating







Scratches on the combined instrument panel and other visuals or holes in the field of vision



Significant soiling, stains and smells requiring chemical cleaning carried out by a professional.

## Others:

-  Signs of carbonisation
-  Significant discolouration
-  Clogged filters
-  Steering wheel cover damaged



**Additional** structures

# Vans



Rear Step Slight deformation



Wood internal protections: Small impacts



Internal deformations: Slight deformation without perforations or cuts, repair time ≤ 3 h



Rear footboards: Deformations within economic repair



Rear footboards: Deformations not within economic repair

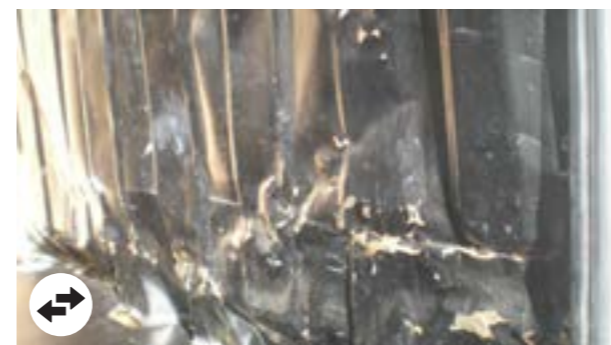

Internal deformations: Significant deformation, repair time > 3 h, perforations, cuts



Internal deformations: Perforations, cuts, deformations beyond economic repair: Denaturing and uncorrectable deposit (powder, paint, etc.) (Wheel arch not recoverable if repair time > 3h)



Wood internal protections: Impacts, torn panel, panel missing (excluding door upper panels)



# 20 m<sup>3</sup> Underbody



Cabover and deflector: Faint scratch in keeping with the vehicle appearance



Side panels: Faint scratch with material removal ≤ 10 cm



Underbody side profiles: Faint scratch



Bike racks: Faint scratch



Side and rear doors: Slight deformation: Repair time ≤ 1 h



Flooring: Slight deformation, superficial wear

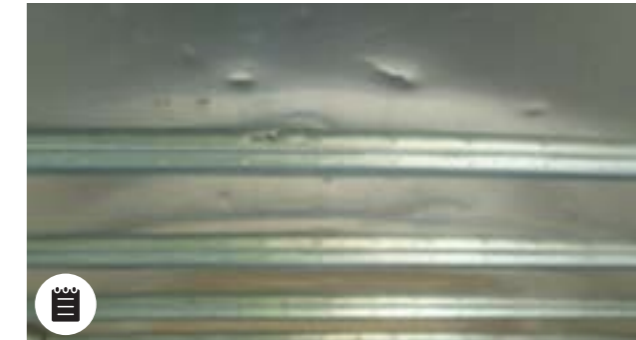

Roof space: Slight deformation in keeping with the vehicle appearance



Upholstery and rods: Carpet torn or detached

# 20 m<sup>3</sup> Underbody



Cabover and deflector: Within economic repair



Cabover and deflector: Significant crack, missing part or beyond economic repair



Side panels: Scratch with removal of material  $\geq 20$ cm within economic repair.  
Option to paint half panel



Wood side panels: Damaged wood support  $\geq 20$  cm



Underbody side profiles: Deformations within economic repair



Fibreglas side panels: Deformation on lower part, length of  $> 1$  m  
NB: Replacement of the front panel of the underbody requires removal of the underbody.



Underbody side profiles: Deformations beyond economic repair, perforations, removal of a section of the profile



Side underun guards: Deformation within economic repair



Tail lift: Deformations of platform within economic repair



Side underun guards: Deformation beyond economic repair





# 20 m<sup>3</sup> Underbody



Tail lift: Deformations of platform beyond economic repair, broken or incomplete trim



Side and rear doors: Significant deformation: Repair time > 1 h within economic repair, closure not sealed



Side and rear doors: Doors bent at fastening points for hinges, broken, perforated, or beyond economic repair



Flooring: Deformations or perforations within economic repair

Deformations or perforations beyond economic repair. Option to exchange flooring by section



PAINTING



REPAIRS



CLEANING



EXCHANGE



MEMO



Roof space: Perforated or torn within economic repair

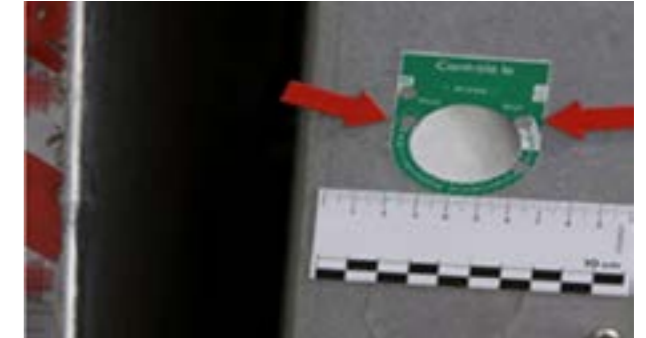

Tail lift: Expired check dates



Roof space: Frame damaged, leather not within economic repair



Upholstery and rods: Rods and upholstery deformed within economic repair



Upholstery and rods: Rods, fastenings, upholstery missing or deformed beyond economic repair

# Hoppers



Faint scratches, Dropside/ Tipper Bodies deformations with a repair time  $\leq$  1 h



Scratches  $>$  20 cm



Deformations in the body closures with a repair time  $>$  1 h within economic repair



Deformations in the body closures not beyond economic repair, closure not possible or not sand-proof



Trace of concrete or chemical product covering  $\geq$  1/4 of the surface of the bed



Trace of concrete or chemical product on the back of the cab

# Tarps



Faint surface scratches (can be removed with cleaning)

Slight damage due to pollution

Faint marks, e.g. from car wash

Slight differences in colour due to the use of different trims or base materials and ageing



Deep scratches through to the fabric

Scratches with significant abrasion

Significant damage due to pollution

Marked discolouration

Unprofessional repairs

Tears in the tarp, eyelets or hooks

Advertisement adhesives or adhesive residue, glue residue



**Vehicle technical** details

# Drive chain, steering, chassis, suspension components and additional components



Signs of wear that do not impair road safety



Light traces of oil (no dripping)

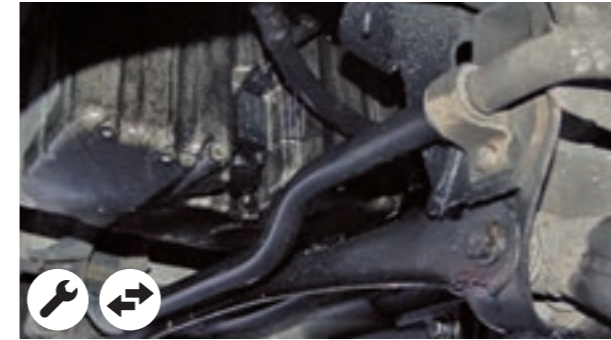

All Leaks from the engine, gearbox and differential, hydraulic suspension and dampers



Leaks from the steering gear and power steering pump



## Others:

- Cracks in suspension bellows and transmission shaft bellows
- Broken springs
- All signs of wear that can be detected via a visual check and do not impair road safety
- Parts for axles, suspension and chassis that are damaged by shocks
- Worn track rods/transverse arms etc.
- Strange noises from the engine, gearbox, differential and drive chain

# Exhaust system

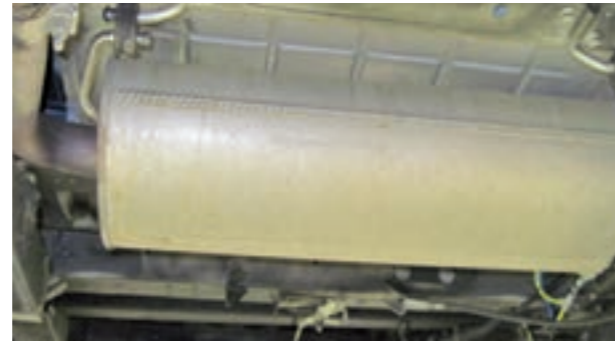

Condition conforms to technical inspection

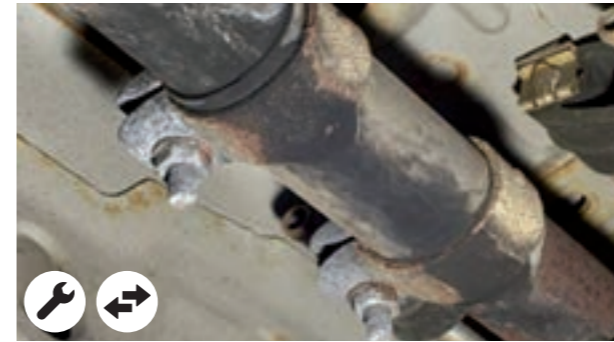

Presence of leaks



Rust

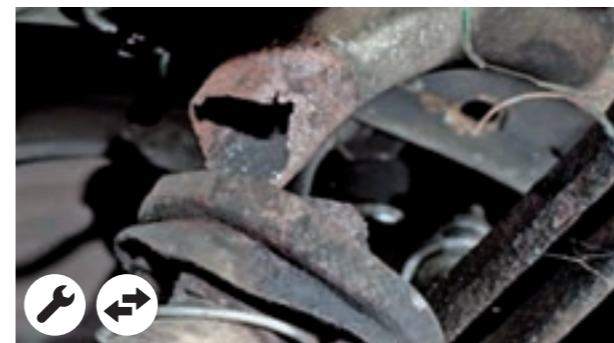

Damage due to external shocks



Missing equipment, e.g. exhaust outlets torn or deformed

# Brake system

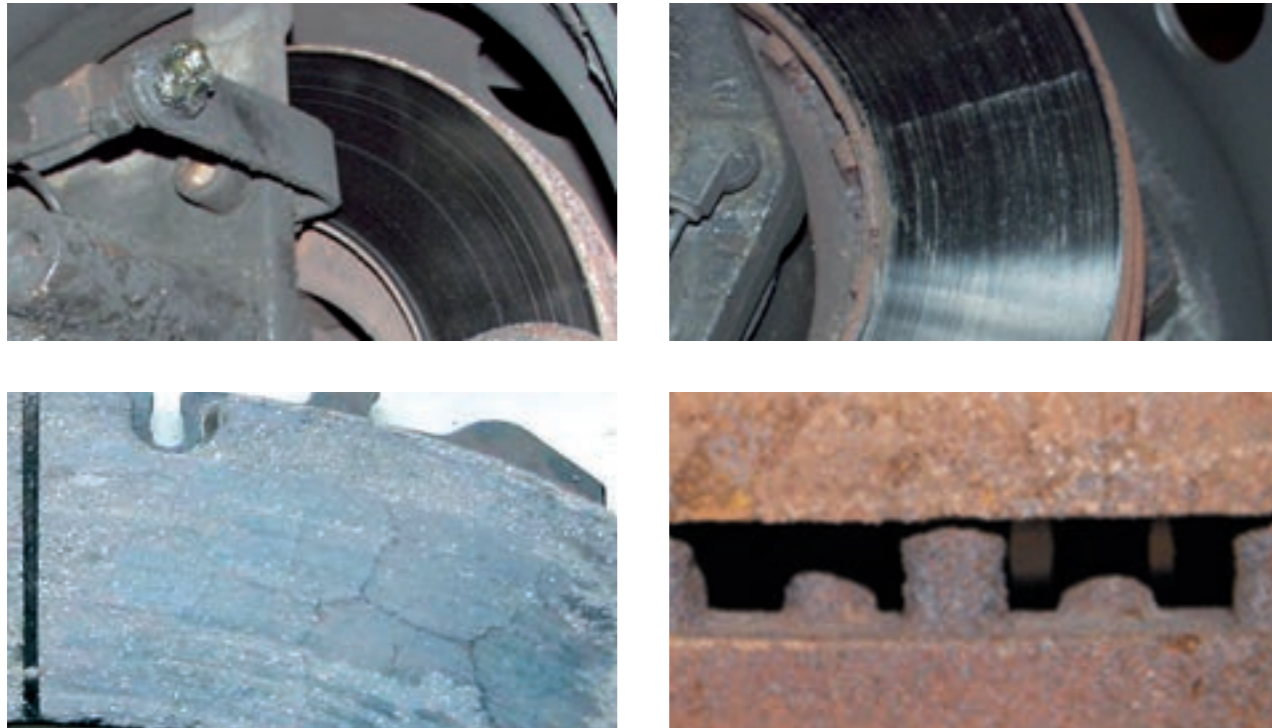

Normal condition and in accordance with the age and mileage of the vehicle



Rusted, ground, worn brake discs

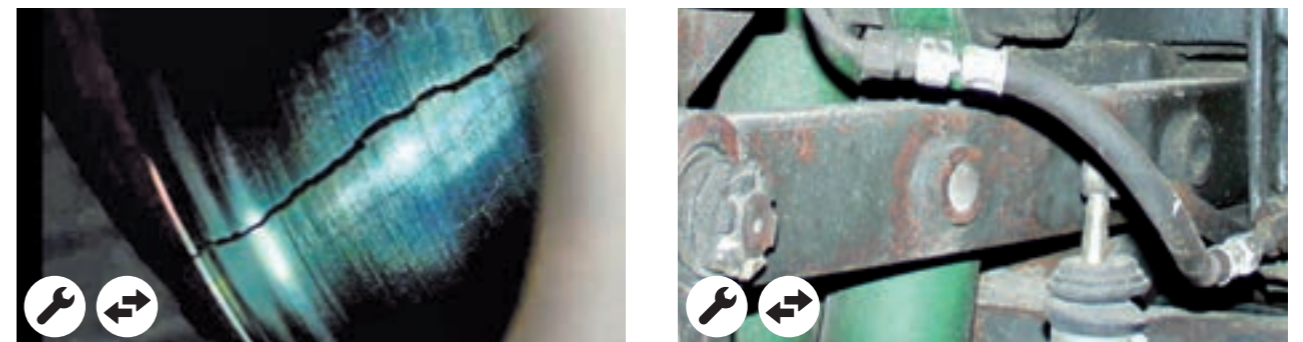

Does not conform to highway code and not valid during technical check

### Others:

- Worn brake linings
- Porous brake lines
- Change to operation
- Damage due to prolonged parking



Others





## Vehicle maintenance

### Introduction

The maintenance activities must be carried out in line with the requirements of the law, the guidelines of the Maintenance and Repair Agreements or any other Service agreement where present and IVECO User's Manual.

It is always recommended to carry out vehicle maintenance in compliance with current legislation and instructions recommended by the manufacturer, and to make use of official IVECO maintenance and repair programs which always guarantee maximum efficiency as they provide vehicles with original spare parts and through a skilled specialist.

Listed below are the documents to be produced when returning the vehicle according to the different possible cases:

#### If the vehicle has a maintenance contract with IVECO and the interventions are carried out at an authorized IVECO network workshop

- No document is required

#### If the vehicle does not have a maintenance contract with IVECO

#### When maintenance interventions are carried out at the customer's expense at an authorized IVECO network workshop

- The warranty booklet with data and stamp of the maintenance carried out at the authorized IVECO workshop

#### Alternative Cases:

- The invoice issued by the IVECO authorized workshop, with information relating to:

- maintenance data
- unique references to the vehicle (VIN or license plate) and mileage at the time of the intervention,
- list of components, lubricants and fluids (with the IVECO PN or the reference to their equivalence in the case of non-original materials) used
- list of maintenance operations carried out

#### When maintenance interventions are carried out at the expense of the customer in a workshop that is not part of the IVECO authorized network

- The invoice issued by the workshop, with information relating to:

- maintenance data
- unique references to the vehicle (VIN or license plate) and mileage at the time of the intervention
- list of components, lubricants and fluids (with the IVECO PN or the reference to their equivalence in the case of non-original materials)
- list of maintenance operations carried out

#### When maintenance interventions are carried out at the customer's expense in its internal workshops

- The purchase invoices of the materials used (components, lubricants and fluids) original or equivalent, in which the purchase data is previous or concurrent with the data of the maintenance intervention
- The internal order that reports that the maintenance intervention was performed on a specific vehicle with unique references to the date of maintenance and to the vehicle (VIN or license plate) and mileage at the time of the intervention

## Standard equipment and documentation, maintenance, revisions



In order to avoid all additional fees and costs, before returning the vehicle check that all the parts and documents belonging to the vehicle are complete. You can use the following list to do this:

- |   |   |
|---|---|
| <input type="radio"/> Service booklet                                 | <input type="radio"/> Key and spare key       |
| <input type="radio"/> Onboard manual/operating manual                 | <input type="radio"/> Remote control with key |
| <input type="radio"/> Registration certificate                        | <input type="radio"/> Warning triangle        |
| <input type="radio"/> Spare wheel or compressor and inflation product | <input type="radio"/> Luggage divider         |
| <input type="radio"/> Tool kit  | <input type="radio"/> Seat covers             |
| <input type="radio"/> Tail lift hitching device                       | <input type="radio"/> Validity of fridge      |
| <input type="radio"/> Navigation CD/DVD                               | <input type="radio"/> Tailgate check          |
| <input type="radio"/> Radio code card (for models with code card)     | <input type="radio"/> Valid MOT               |

## Frequent questions

### 1. What is the vehicle return process?

You will be contacted via letter or email three months prior to the expiration of your contract, in order to remind you of the rules for returning the vehicle and to give you time to prepare the vehicle in line with the contract.

An inspection must be organised between you and IVECO certified preowned in the two weeks prior to the end of your contract, the protocol will be detailed below.

On demand or volume return (e.g. > 20 units) a preliminary inspection can be organised in the four weeks prior to the end of your contract.

The damage estimation will be carried out by a third party.

Return location: The vehicle must be returned to the set location in accordance with the return conditions.

### 2. What do I do if my contract has been extended or I am interested in buying my vehicle?

If you are interested in extending your current contract or buying the vehicle, please contact IVECO or your dealer in the three to six months prior to the expiration date of your contract. If a contract is extended, the period and mileage will be requested by your commercial point of contact in order to calculate your offer extension.

### 3. When must I return my vehicle?

On the date agreed upon with IVECO or later on during the last day of the contract in accordance with the return conditions.

### 4. What happens if I return my vehicle after the expiry date of the contract?

Charges will be applied if the vehicle is returned after the date stated in the contract.

### 5. What happens if my vehicle does not comply with the return conditions?

Charges will be applied for the repair work required to ensure the return conditions are met, unless the level of damage is greater than the authorised threshold stated in the repurchase agreement.

### 6. What happens if I do not agree with the repairs I am charged for?

The evaluation carried out by an independent expert is final; if you do not agree with it, you can request your own evaluation by an independent expert at your own cost.

## Contract options

### CONTRACT EXTENSIONS

If you would like to extend your contract, please contact the IVECO certified preowned centre in your region or ask to speak to the Administration department.

### VEHICLE RETURN

If we do not receive a request for an extension of your contract, we will assume that the goods are returned to us on the date of the end of your contract previously agreed upon.

This damages catalogue is available and can be accessed at [www.iveco-preowned.com](http://www.iveco-preowned.com)



# Appendix to the vehicle return guidelines

# Foreword

The damage inspection rules specific to vehicle gas supply systems have been drawn up based on and in full compliance with the detailed inspection control (GFBM for CNG vehicles, valid for Italy only).

## Before the expert inspection

The protective covers on the CNG cylinders must be removed by the customer to allow the vehicle return inspection report to be carried out. The customer must refit them before the vehicle is taken to the storage facility.

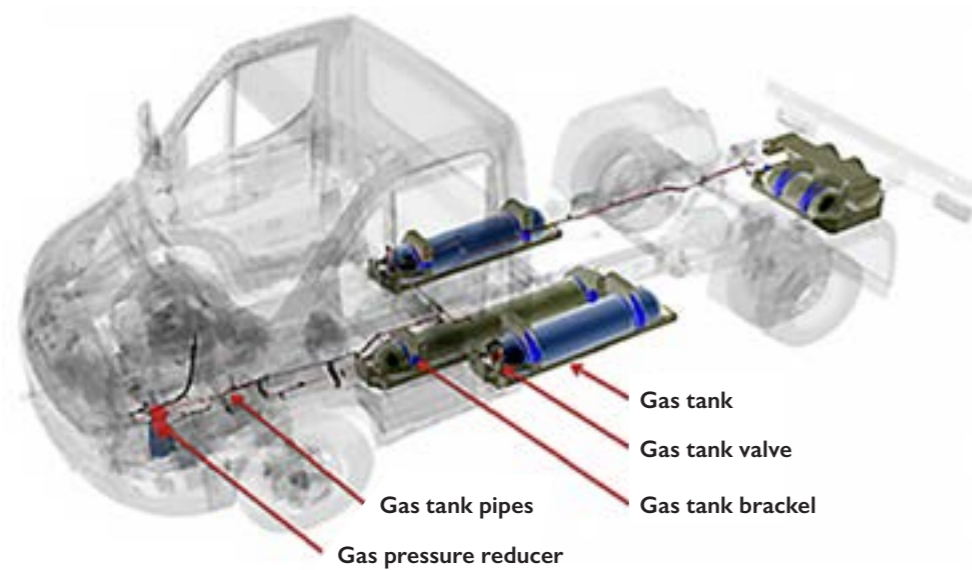

## After the expert inspection

The protective covers on the CNG cylinders removed to allow the inspections report to be carried out must be refitted by the customer before the vehicle is taken to the storage facility.





# Content

Foreword	71
Administrative and markings	74
CNG tank	76
CNG cylinders	78
CNG protective cover	80
Retainer brackets and bands	82
Coupling elements check	84
Medium pressure pipe	86
High pressure pipe	88
Rigid lines for CNG cylinders	90
Gas leakage detection	92
Tightening torques check	94
Fis check	96
Inspection gasoline fuel line	98

# Administrative and markings



Presence of an up-to-date validity certificate legible for CNG cylinder.

Notes: According to, each cylinder shall be visually inspected at least every **UN/ECE-R110 regulation 48 months** after the date of its entry into service on the vehicle (vehicle registration), and at the time of any reinstallation, for external damage and deterioration.



Original CNG cylinder identification markings absent or illegible

- charge for replacement of CNG tank with a new one

# CNG tank



CNG tank must be returned in proper conditions as illustrated in pictures.

Notes: According to regulation UN ECE R110 Each cylinder shall be visually inspected at least every 48 months after the date of its entry into service on the vehicle (vehicle registration), and at the time of any reinstallation, for external damage and deterioration



- Evidence of **tank repairs** → charge for tank replacement.
- **Tank holed** → charge for tank replacement.
- **Dent in outer shell:**
- Maximum depth of deformation  $\leq 7 \text{ mm}$  with no signs of frost or sweating → note without charge for damage (note in the expert report).
- Depth of deformation  $> 7 \text{ mm}$  → charge for tank replacement.
- Dents on the rear head or on the protective shroud → charge for tank replacement.
- **Surfaces scratches** in outer shell → note without charge for damage.
- Any visual **ice or frost spot** on the outer shell or heads (excluding knuckle and its mounted plumbing) → charge for tank replacement.
- Dents, cracks, splits or visible **leaks at the weld seams or on welded components** → charge for tank replacement.
- Any cracks, splits or visible **leaks on the outer shell, rear head or protective shroud** → charge for tank replacement.
- **Damage to the fill receptacle or VENT valve** → charge for replacement of components.
- Inspect the **pump-out port or cap for signs of damage** or tampering. **Half round cap** must be intact and secured to the tank. If not present → charge for tank replacement.

# CNG cylinders



CNG cylinders must be returned in proper conditions as illustrated in pictures.



Evidence of repairs to the CNG cylinder → charge for replacement for CNG cylinder.

- Holes in the CNG cylinder → charge for replacement for CNG cylinder.
- Dents on the CNG cylinder:

If no metal is detached and the maximum depth of the deformation is  $\leq 1.6$  mm and  $\leq 50$  mm in diameter/length → note without charge for damage.

**Detachment of metal or maximum depth of deformation  $> 1.6$  mm and  $> 50$  mm in diameter/length → charge for replacement of CNG cylinder.**

- Cuts/scratches/gouges/abrasions on the CNG cylinder:

**Depth of damage  $\leq 0.25$  mm → note without charge for damage.**

**Depth of damage  $> 0.25$  mm → charge for replacement of CNG cylinder.**

- Corrosion, pits, corrosion lines caused by a chemical, oxidation or rusting of material:

**Depth of damage  $\leq 0.25$  mm → note without charge for damage.**

**Depth of damage  $> 0.25$  mm → charge for replacement of CNG cylinder.**

- Gas leakage from any CNG cylinder or component, due to a defect → charge for replacement of the CNG cylinder or component.
- Bulge/visible swelling of the CNG cylinder → charge for replacement of the CNG cylinder.
- Permanent traces of chemical attack/permanent discoloration, loss of material from the CNG cylinder → charge for replacement of the CNG cylinder.
- Permanent traces of charring/soot/blackening/dyscoloration, evidence of fire or excessive heat exposure of an area of the CNG cylinder → replacement of the CNG cylinder.



# CNG tank and cylinders protective cover



CNG cylinders protective covers must be returned in proper conditions as illustrated in pictures.

Dents, deformations, rust and/or gouges that do not affect functionality and safety are accepted.

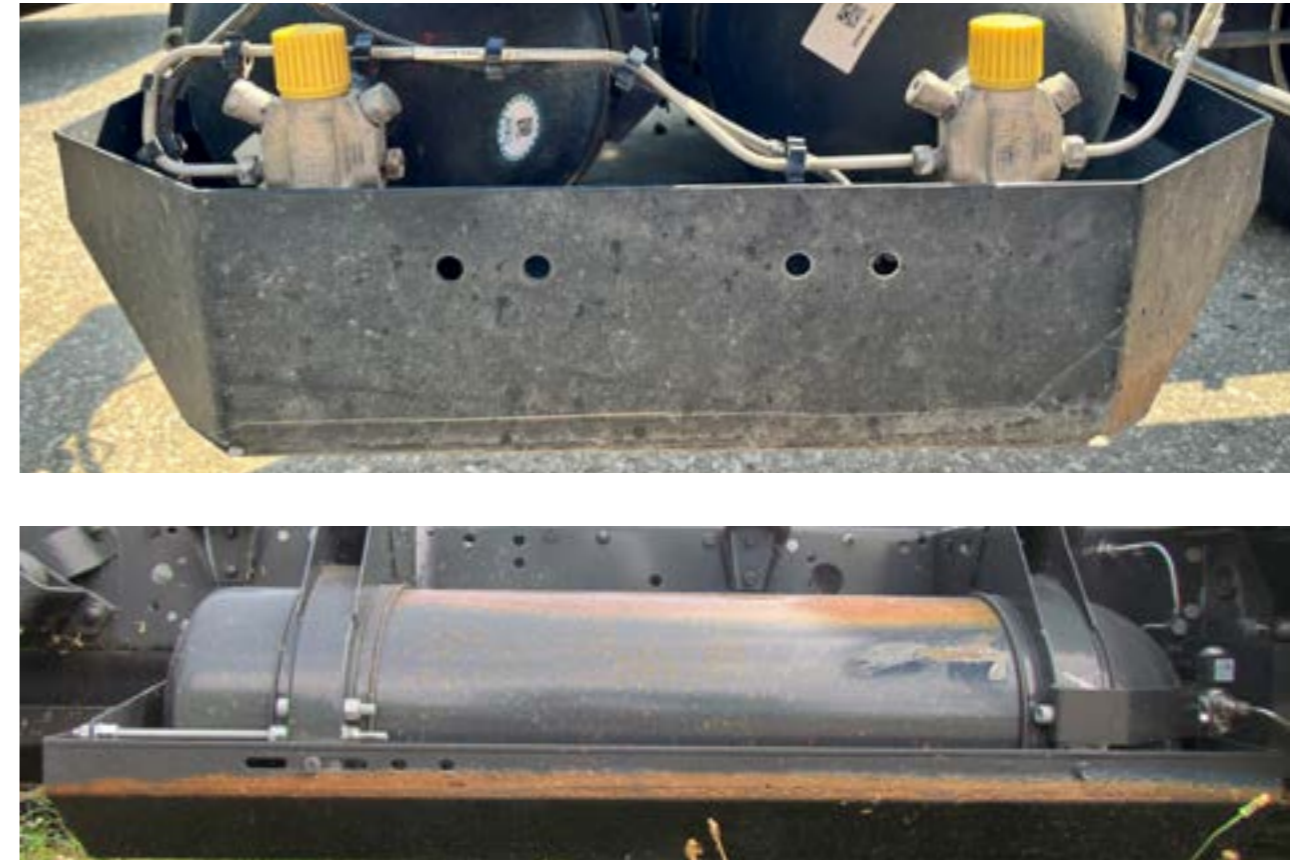

Visible dents and deformations that affect the functionality and/or safety

- charge for replacement of protective covers.

Rust, breakages and/or gouges that affect the functionality and/or safety

- charge for replacement of protective covers.

Where the covers are absent

- charge for the replacement of these.

# Retainer brackets and bands for CNG cylinders and tanks



CNG cylinders must be returned in proper conditions as illustrated in picture.

Rubber must be followed the edge of the brackets.

Check that the brackets are present and properly tighten (see following pages).



Rust, dents, breakages and/or gouges

- charge for replacement of brackets and bands.

# Coupling elements check

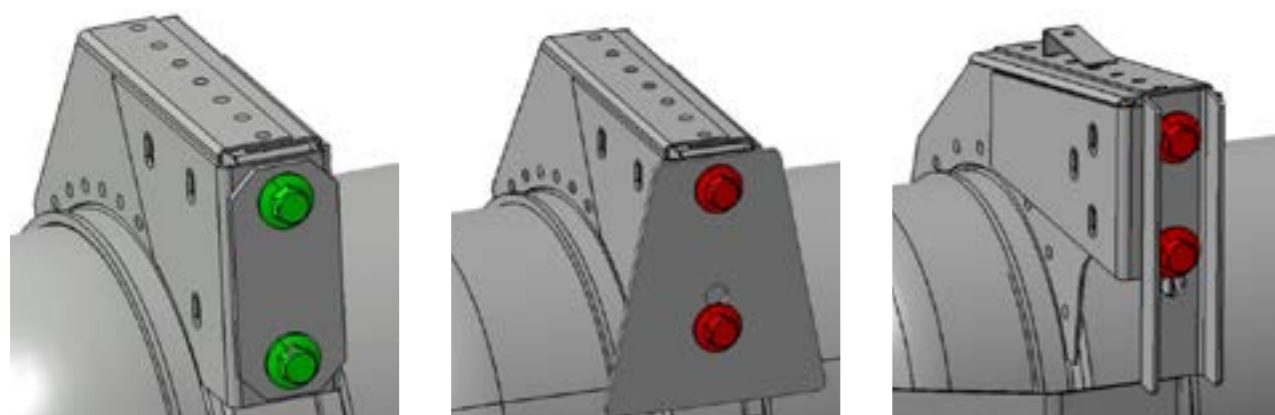

Tank support brackets to chassis and rear cross member fastening with stiffening plates



Band to tank bracket fastening: check the status of components (oxidation, fatigue, etc.)

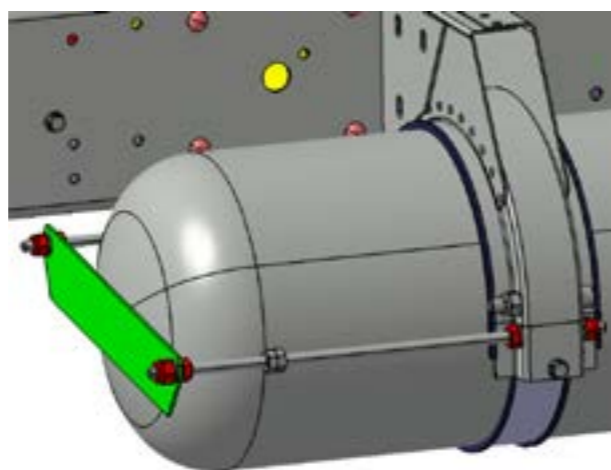

Tank tie-rod fastening: it maintain the tank in case of crash. Check the status of components.

Check that all the elements described above are present and properly tighten.

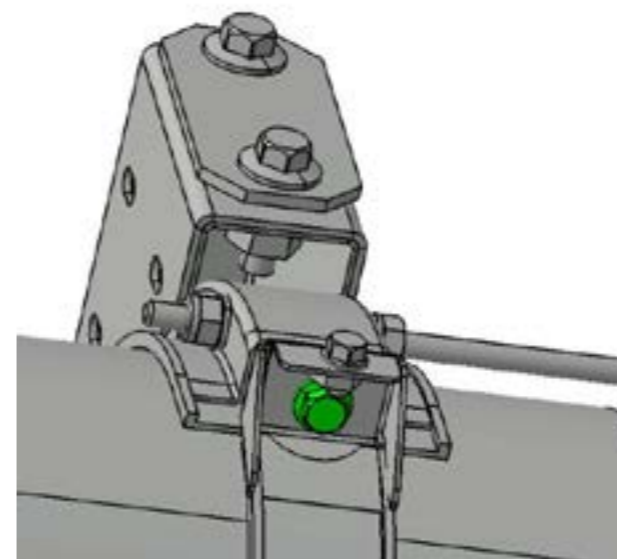

Tank support band fastening. The support is also checked in case of vehicle inspection (Italy Market: each 4 years)

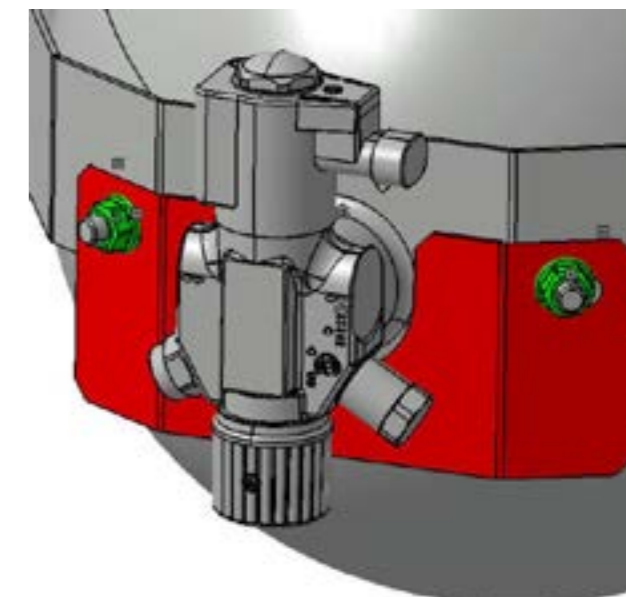

Firewall bracket fastening. The support is also checked in case of vehicle inspection (Italy Market: each 4 years)

# Medium pressure pipe

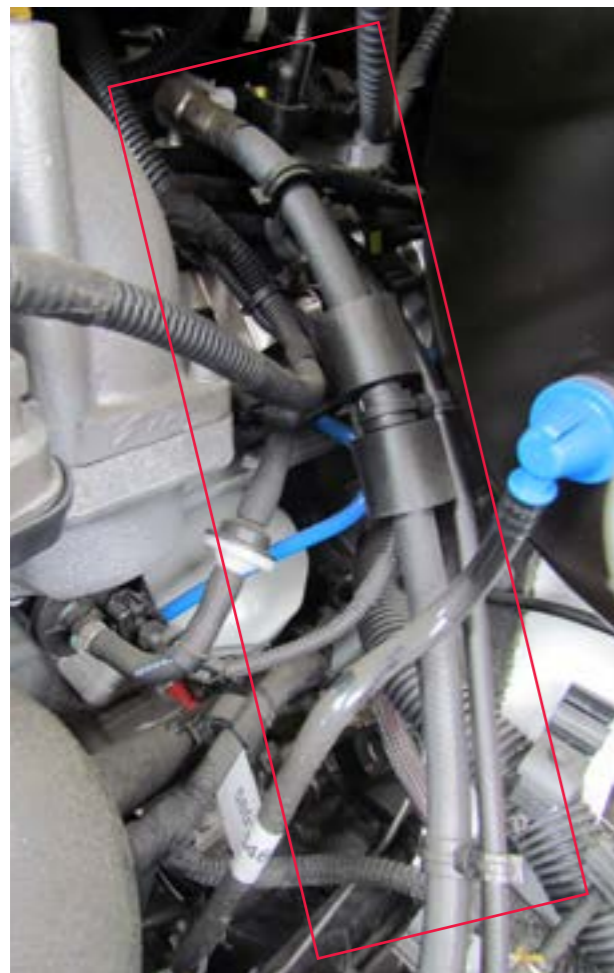

Medium pressure pipe must be returned in proper conditions as illustrated in picture.



Cuts/scratches/gouges/abrasions  
• charge for replacement of medium pressure pipe.



# High pressure pipe



High pressure pipe: it must be returned in proper conditions as illustrated in pictures.



Cuts/scratches/gouges/abrasions

- charge for replacement of high pressure pipe.

# Rigid lines for CNG cylinders



Rigid lines must be returned in proper conditions as illustrated in pictures.



Rust, dents, breakages and/or gouges  
• charge for replacement of rigid lines.

# Gas leakage detection



1. Use a spray leak detector
2. In the leakage warning area, apply on junction potentially involved specific product spray («1000 bolle»)
3. A leakage should generate bubbles like pictures in red section



# Tightening torques check

To verify through gas leakage detector

High-Pressure Hose  
Connection to Filler Inlet

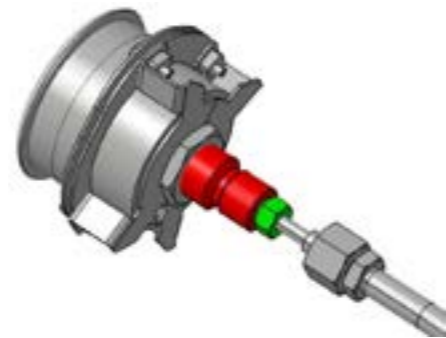

## COUPLING ELEMENTS:

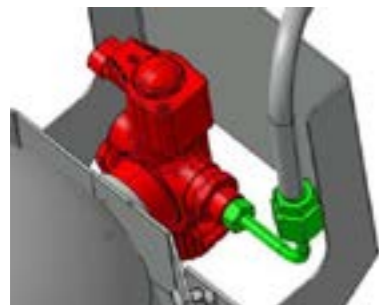

High-pressure hose connection to the check valve on the solenoid valve

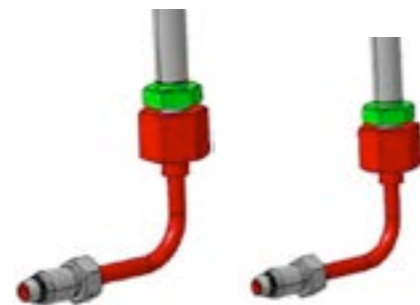

Fittings on high-pressure hose

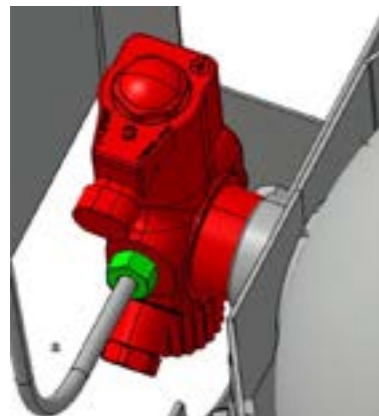

Connection of stainless steel rigid piping to solenoid valve



Blind plug on solenoid valve



### Note:

Check that all the elements described above are present and properly tighten.  
Check that fuel filler cap is present and properly tighten.

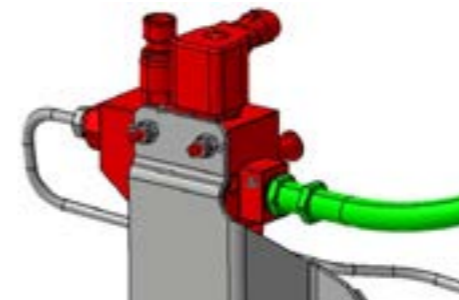

Medium-pressure hose connection to the pressure reducer

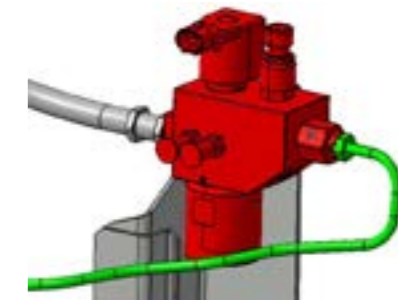

Stainless steel rigid pipe connection to pressure Reducer (Russia Market)

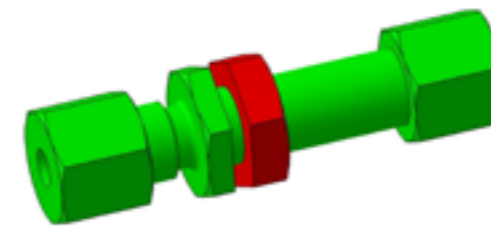

Fastening through coupling to chassis

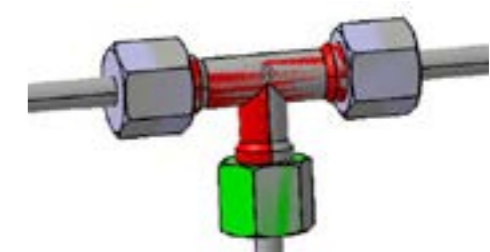

Stainless steel rigid pipe connection to "T" fitting Or through coupling



Filler cap to support fastening



# FIS (Inertial safety switch) check



**FIS:**  
Inertial Safety Switch

- To remove electrical connection
- During key on, the Electro Valve (EV) must be remained off



EV



FIS Positioning

# Inspection of gasoline fuel line



Check integrity of the gasoline fuel lines (no losses, no evidence of deep scratch). Fuel lines must be returned in proper conditions as illustrated in picture.



Losses or evidences of deep scratches

- charge for replacement of fuel lines.

## Notes

## Notes

## Notes

## Notes

**IVECO**  
CERTIFIED PRE-OWNED

**IVECO**  
Drive the road of change

PUBLICATION H2332501 MASTER - 04/24

The information and images in this catalogue are provided as a guideline only. IVECO reserves the right to make changes for any commercial or construction reasons at any time without notice.